

FIG. 1

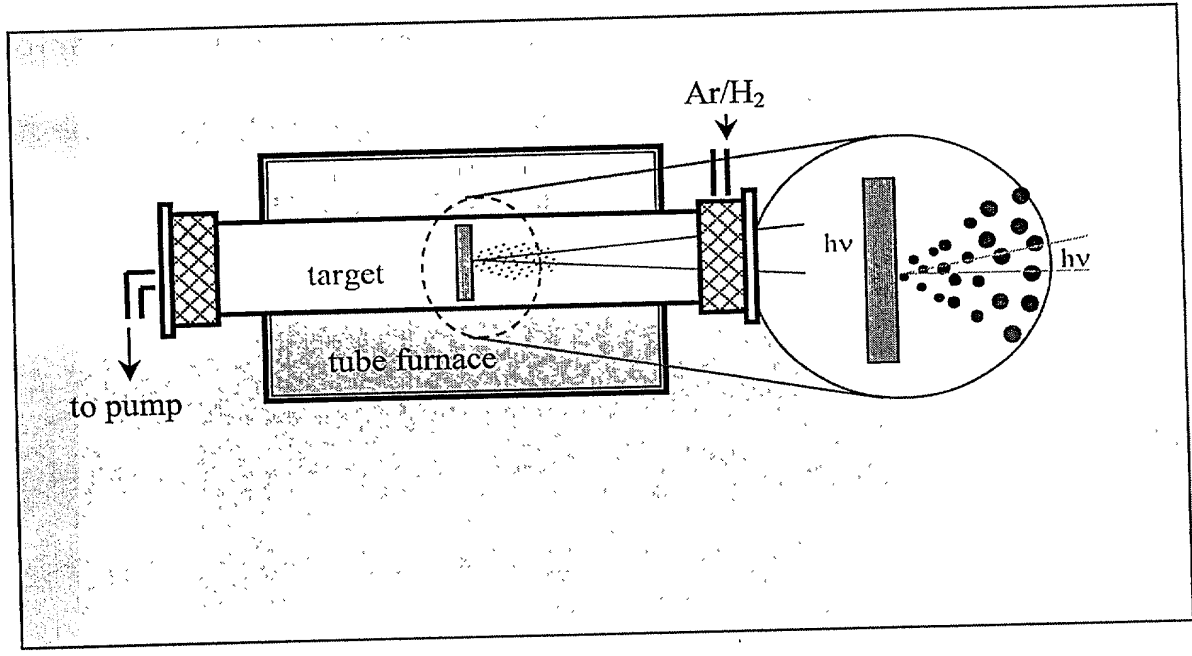


FIG. 2

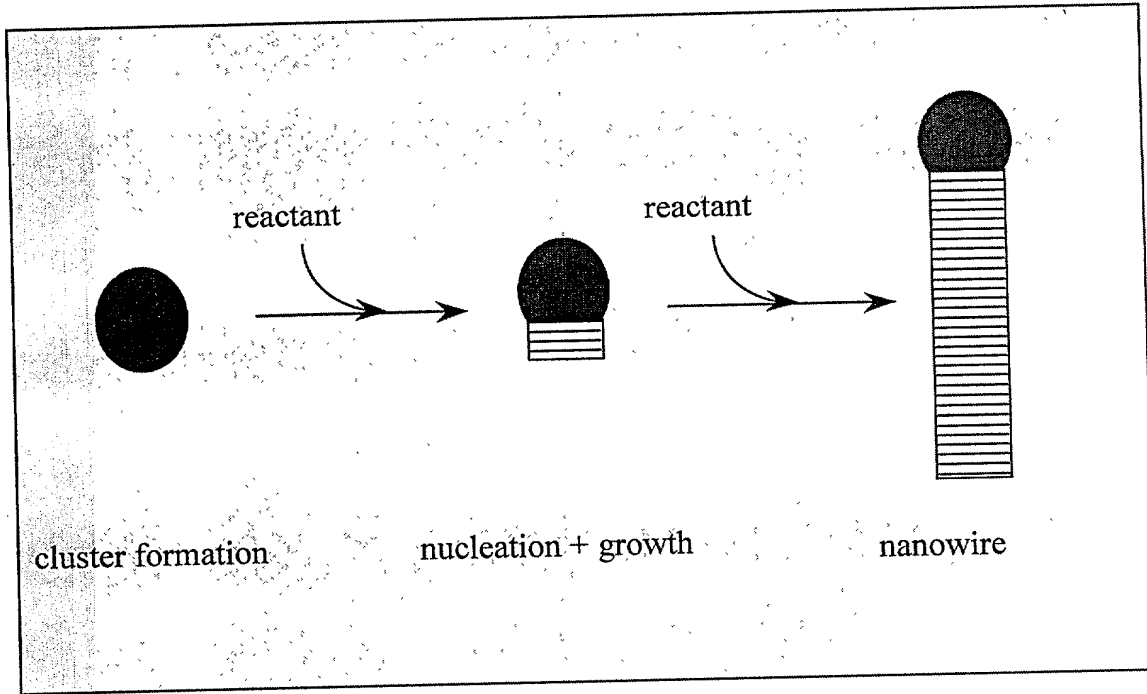


FIG. 3



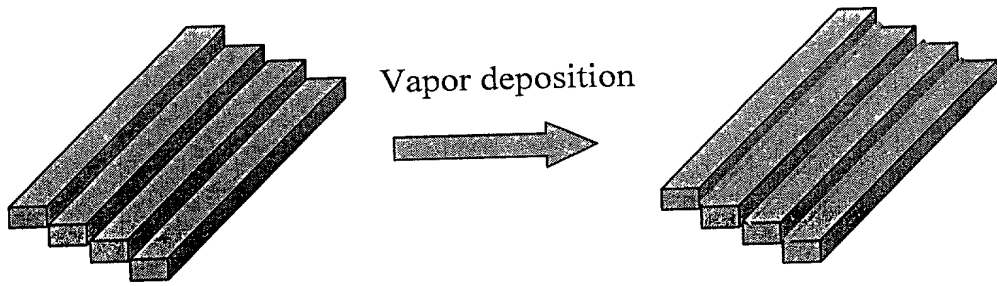


FIG. 5

Copyright © 2000, Intel Corporation. All rights reserved. Intel, the Intel logo, and Pentium are trademarks or registered trademarks of Intel Corporation or its subsidiaries in the United States and other countries.

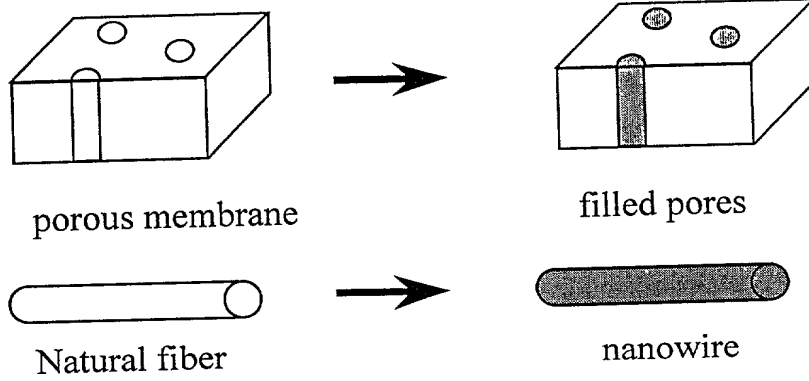


FIG. 6

Downloaded from ascelibrary.org by University of California, San Diego on 06/01/15. Copyright ASCE. For all rights reserved.

# Orthogonal Assembly of Semiconductor Nanowires

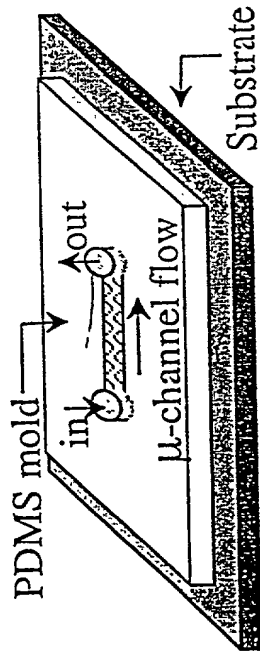


FIG. 7A

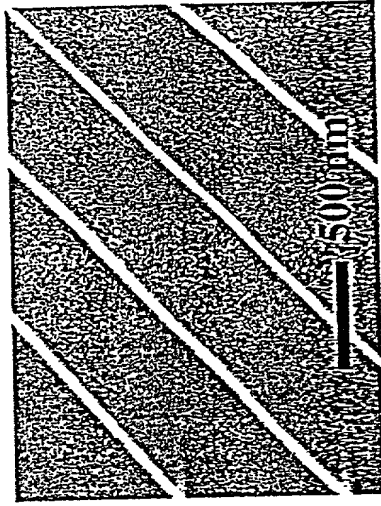
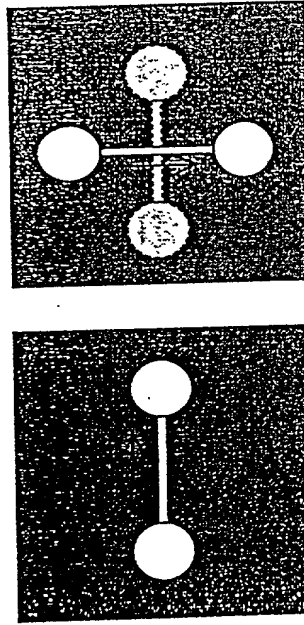


FIG. 7B



First layer

FIG. 7C

Second layer

FIG. 7D

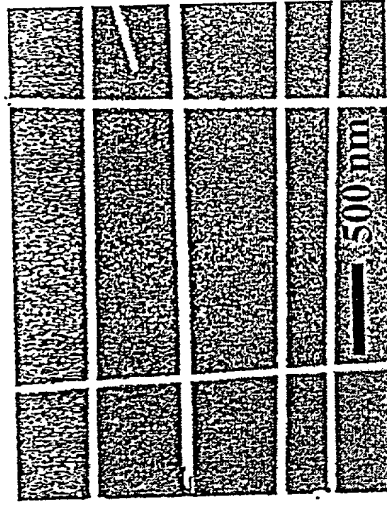


FIG. 7E

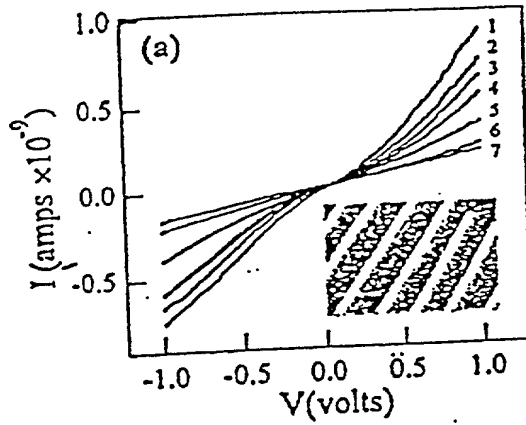


FIG. 8A

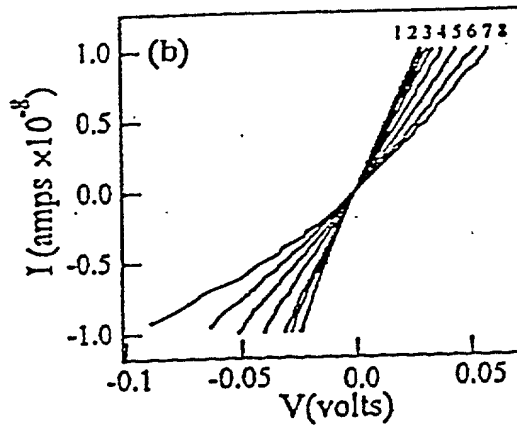


FIG. 8B

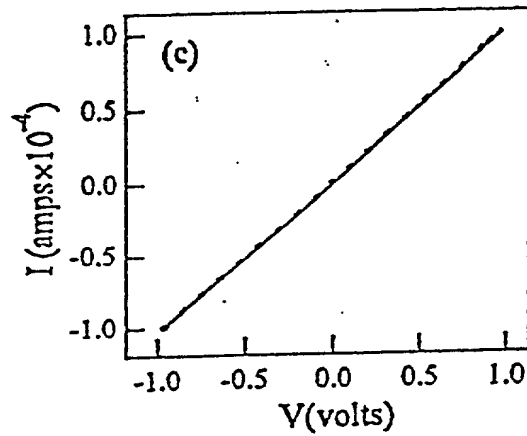
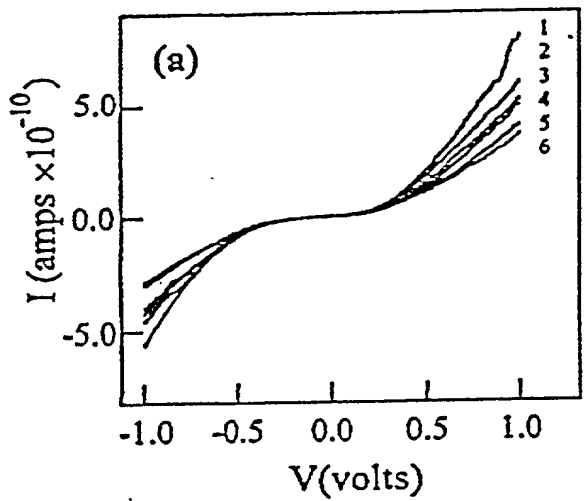
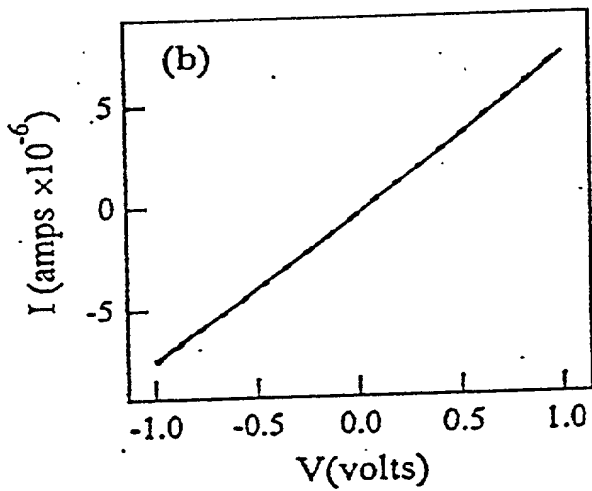


FIG. 8C





**FIG. 9A**



**FIG. 9B**

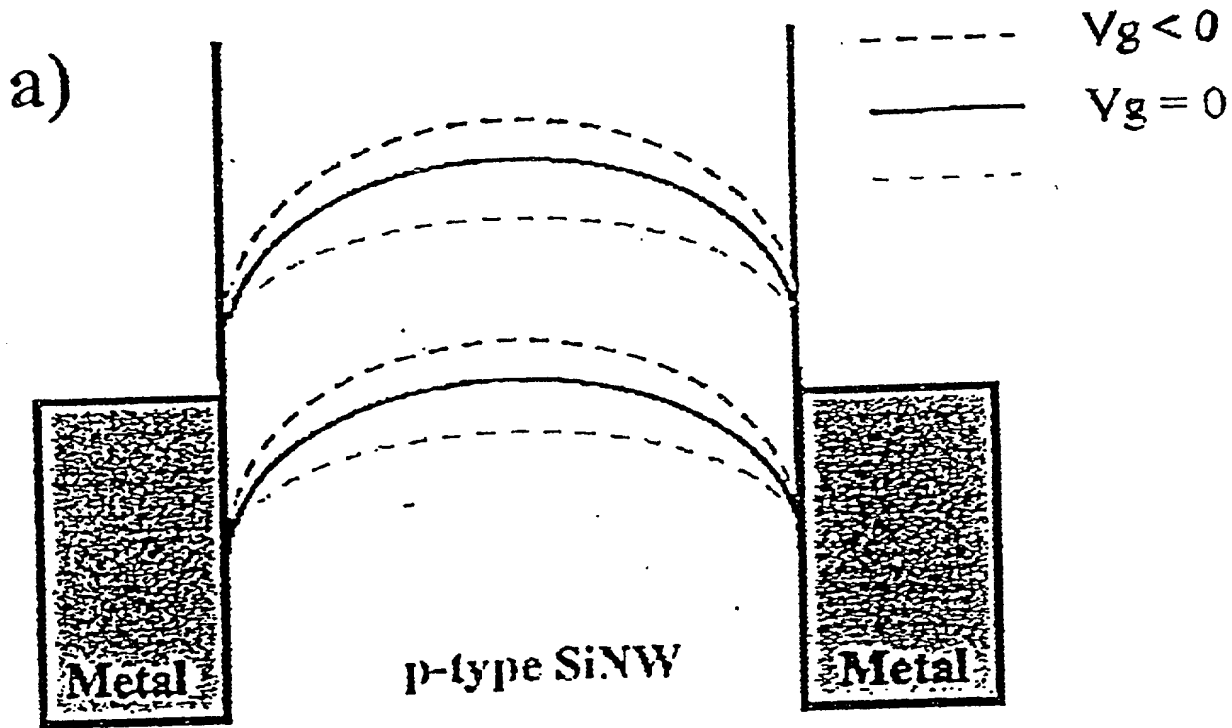


FIG. 10A

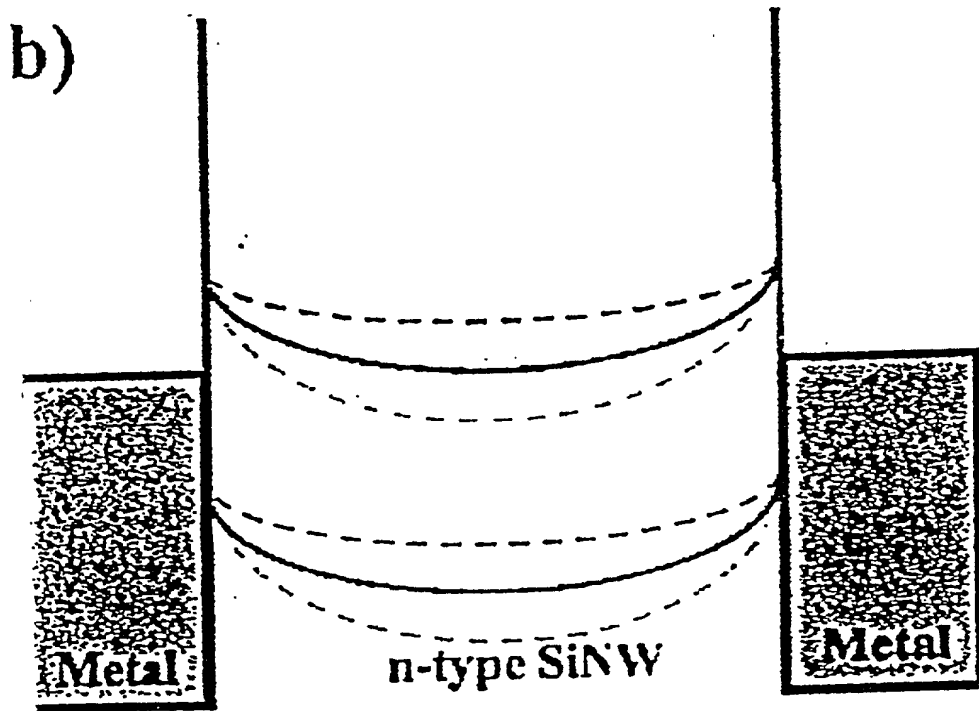


FIG. 10B

Downloaded from ascelibrary.org by University of California, San Diego on 06/16/15

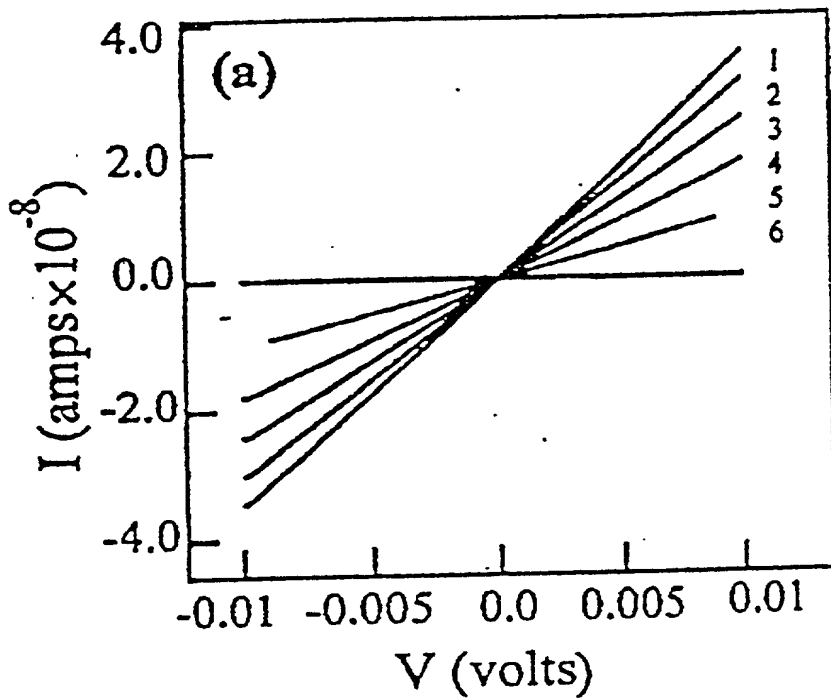


FIG. 11A

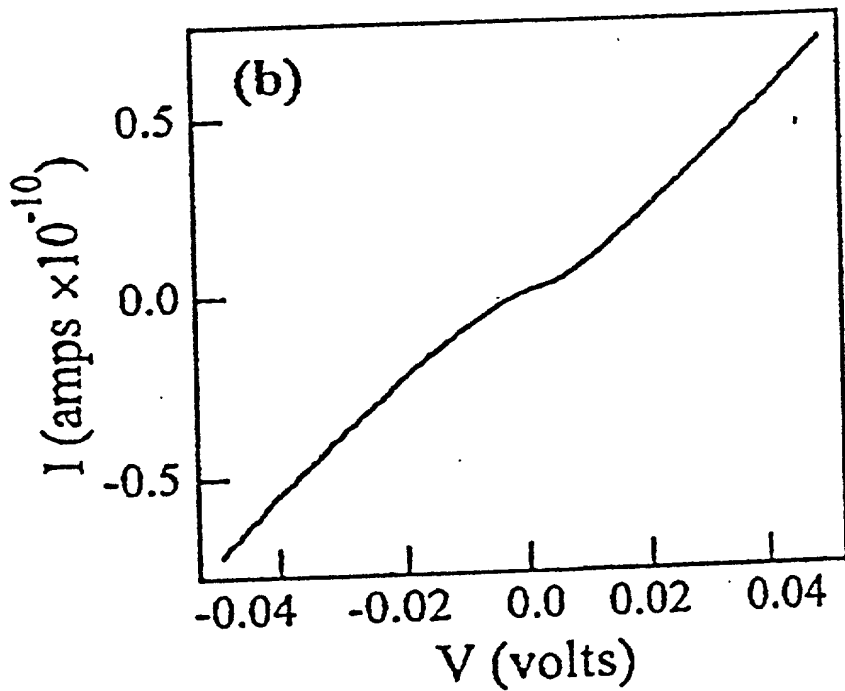


FIG. 11B

U.S. GOVERNMENT PRINTING OFFICE: 1964 O 345-000





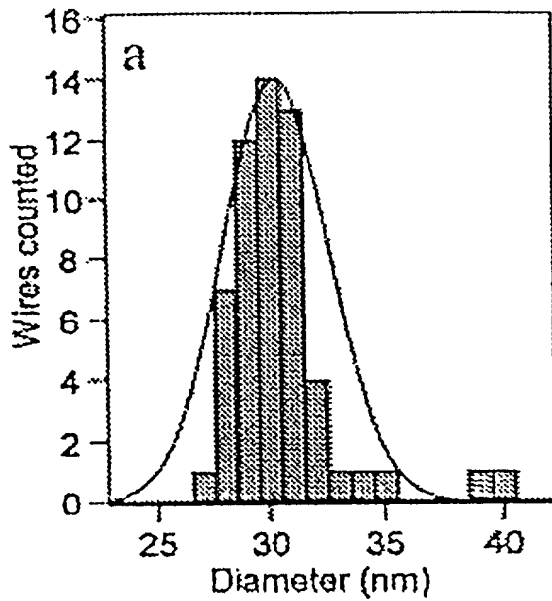


FIG. 14A

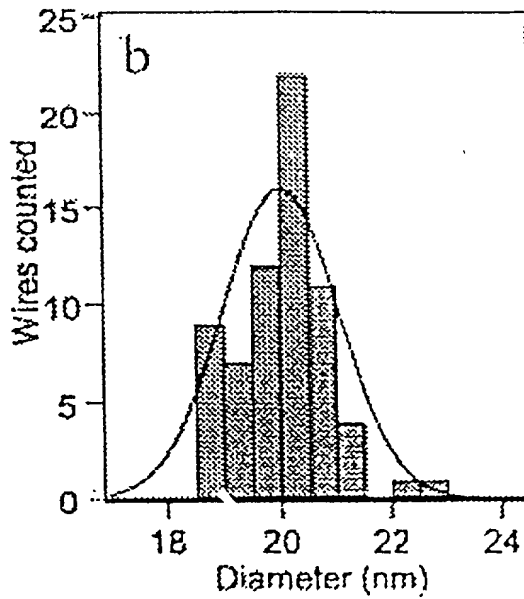


FIG. 14B

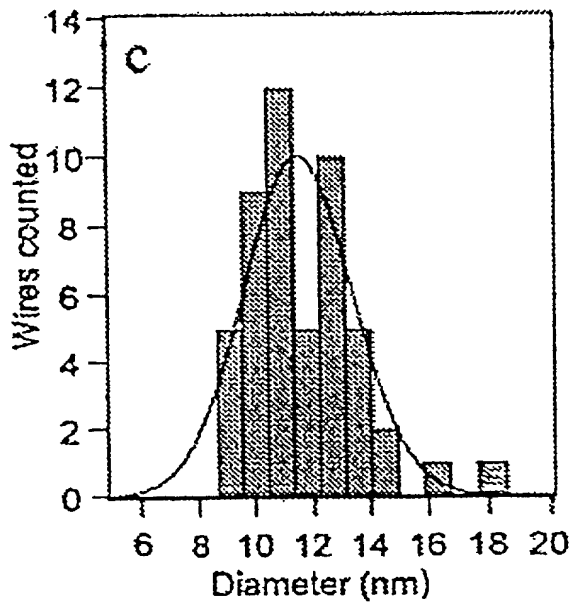


FIG. 14C

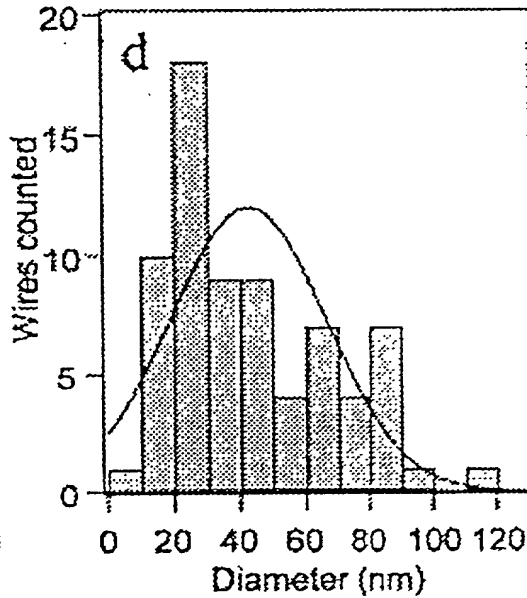


FIG. 14D

Downloaded from ascelibrary.org by Seattle University on 06/01/15

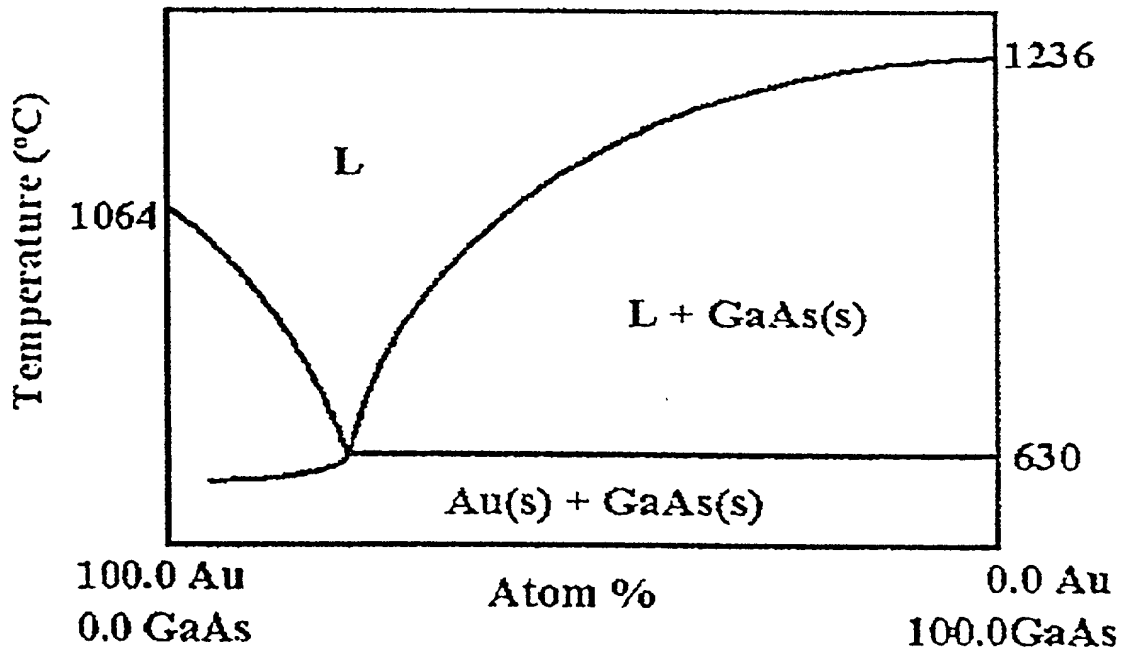


FIG. 15

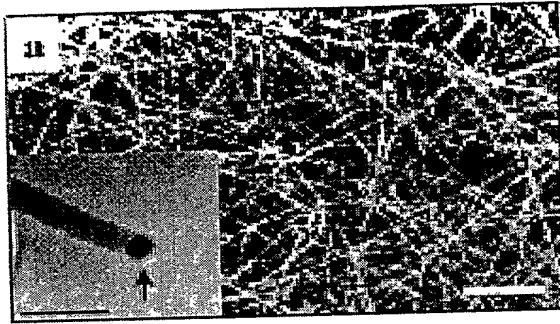


FIG. 16A

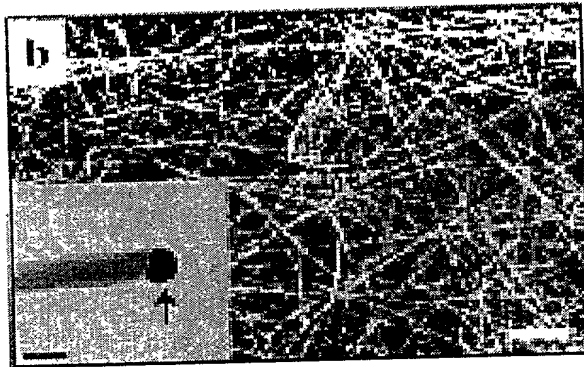


FIG. 16B

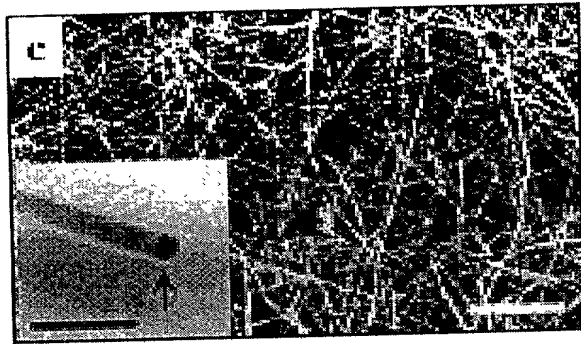


FIG. 16C

Downloaded from ascelibrary.org by Seattle University on 06/16/15. Copyright ASCE, For All Rights Reserved, No part of this document may be reproduced, stored in a retrieval system, or transmitted, in any form or by any means, electronic, mechanical, photocopying, recording, or by any information storage and retrieval system, without permission in writing from the American Society of Civil Engineers.



PHOTOCOPIED FROM THE ORIGINAL

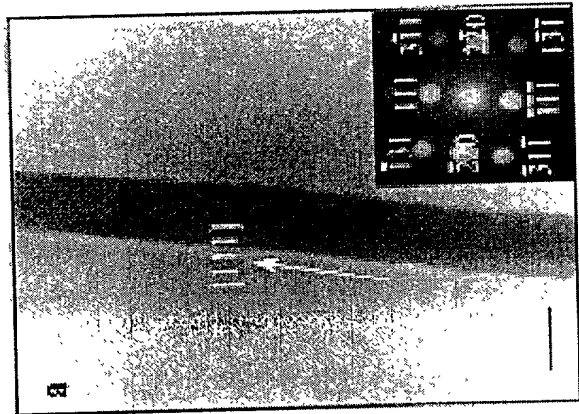


FIG. 17A

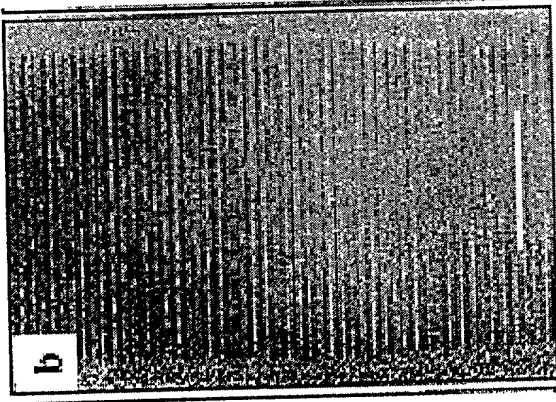


FIG. 17B

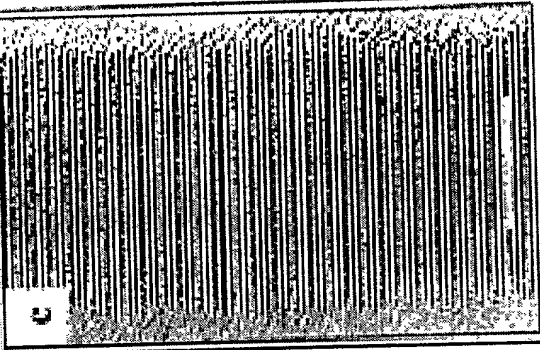


FIG. 17C

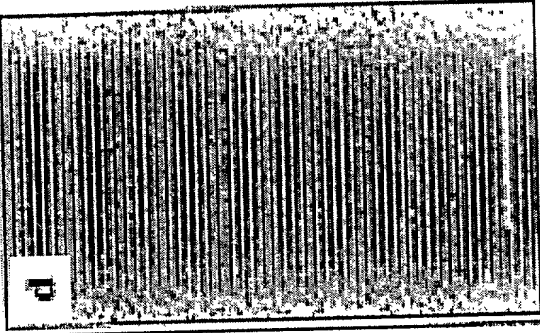


FIG. 17D

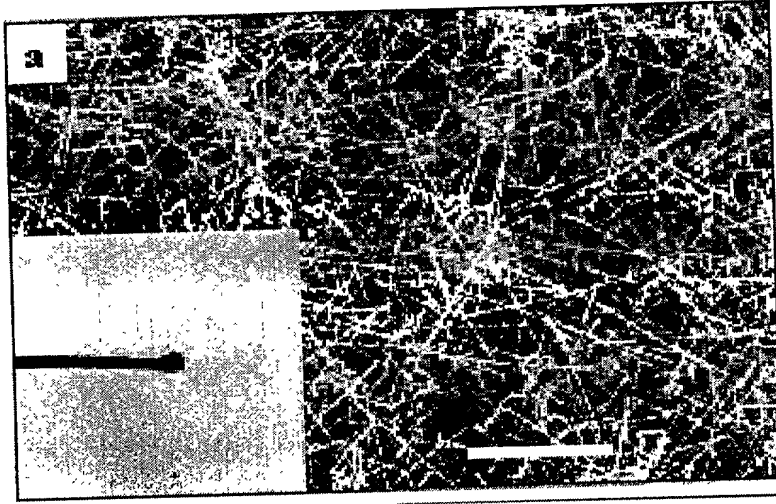


FIG. 18A

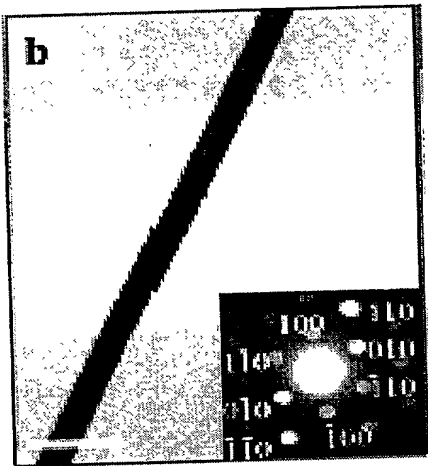


FIG. 18B

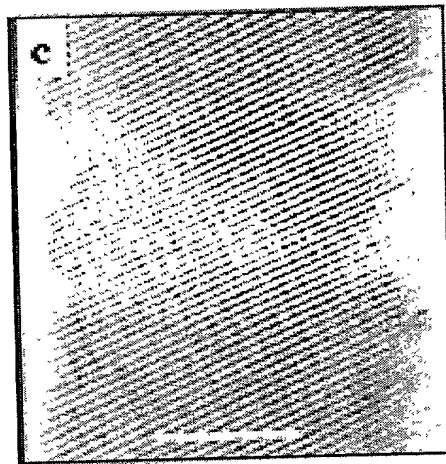


FIG. 18C

U.S. GOVERNMENT PRINTING OFFICE: 1963 O 348-000

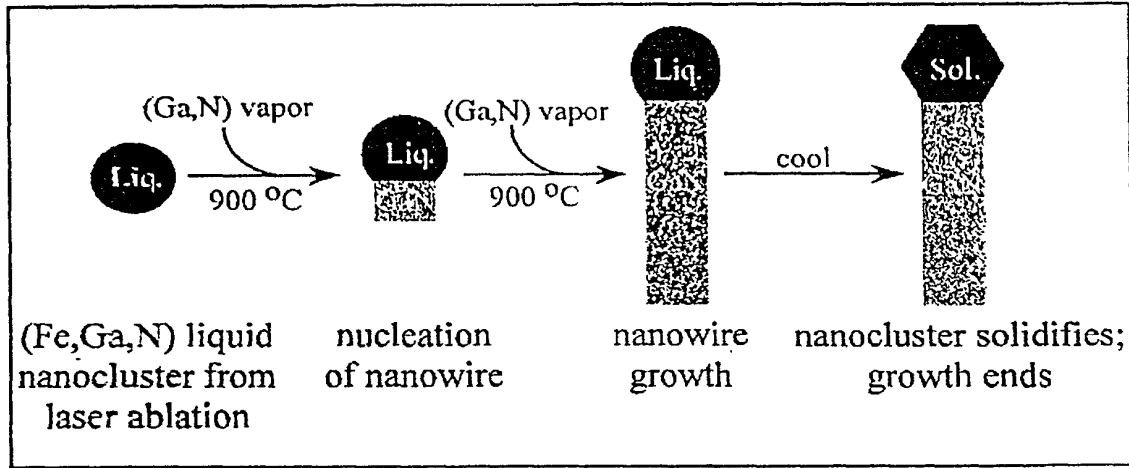
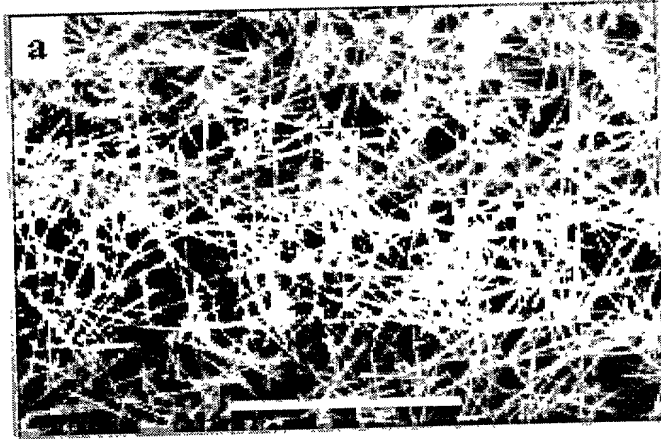
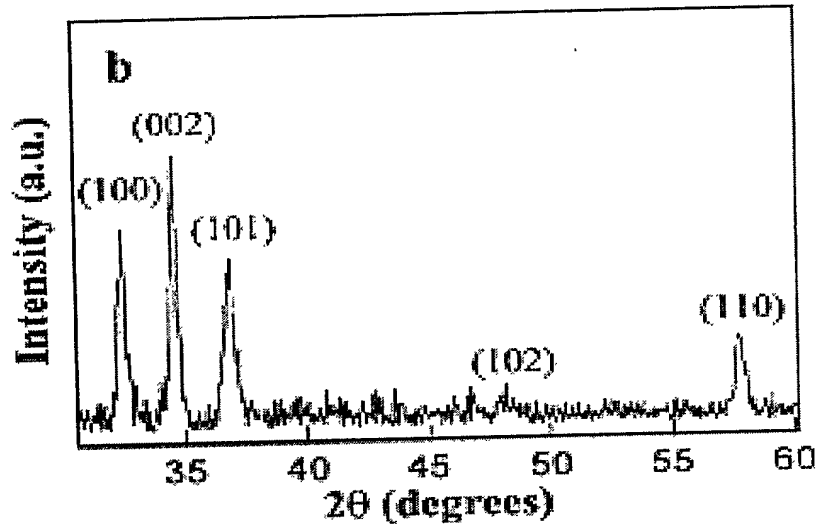


FIG. 19

Copyright © 2004 by John Wiley & Sons, Inc.



**FIG. 20A**



**FIG. 20B**

FOR SCIENCE

2025 RELEASE UNDER E.O. 14176

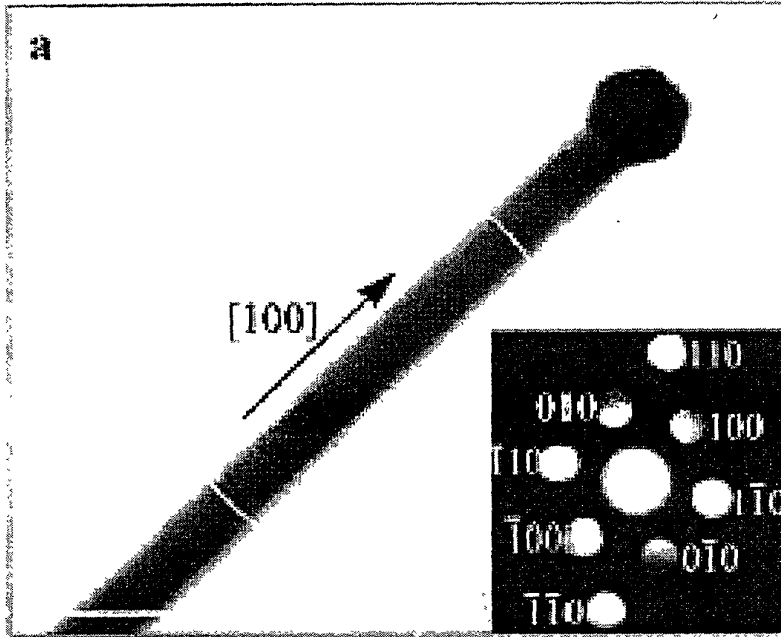


FIG. 21A

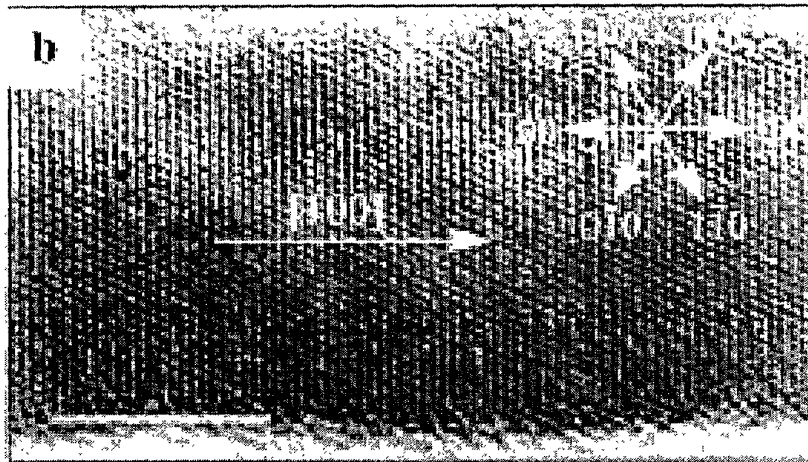


FIG. 21B

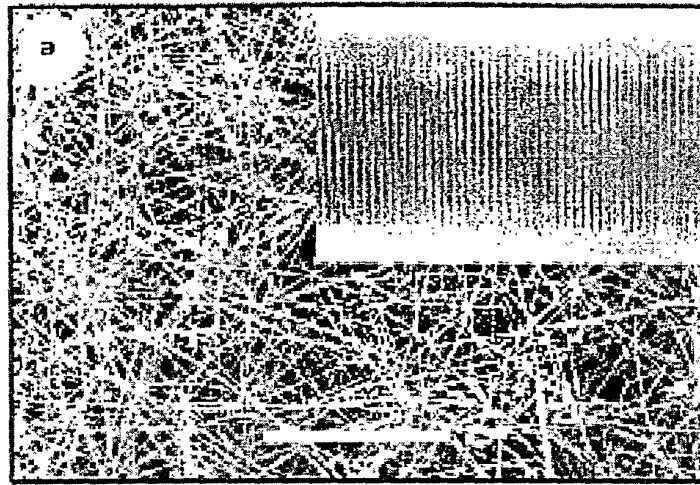


FIG. 22A

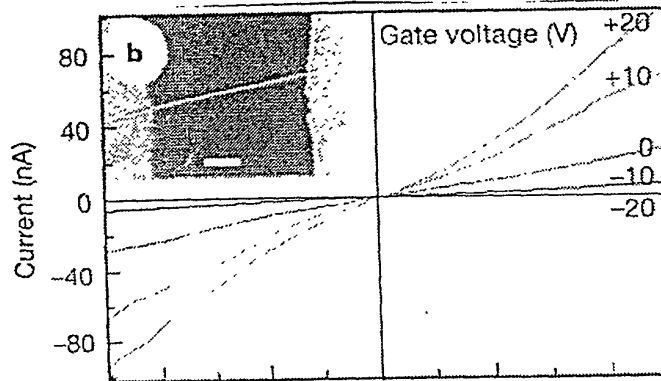


FIG. 22B

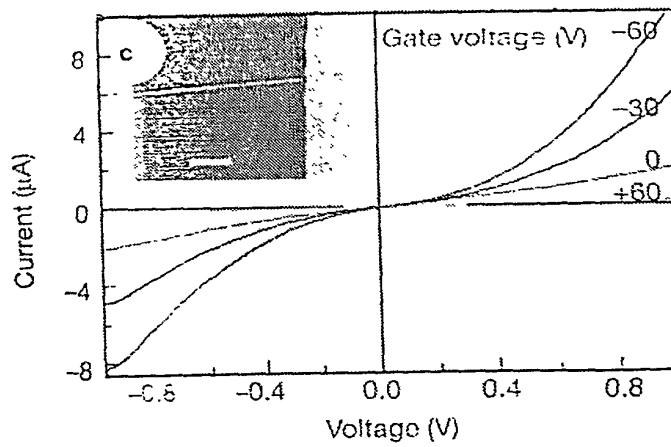


FIG. 22C

PHOTOCOPIED FROM MICROFILM

2025 RELEASE UNDER E.O. 14176

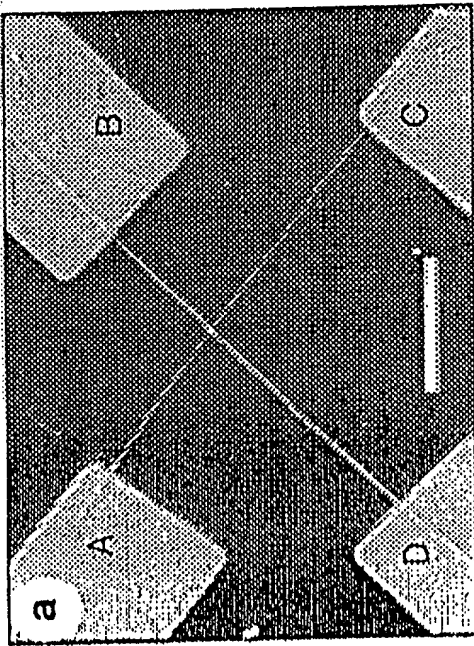


FIG. 23A

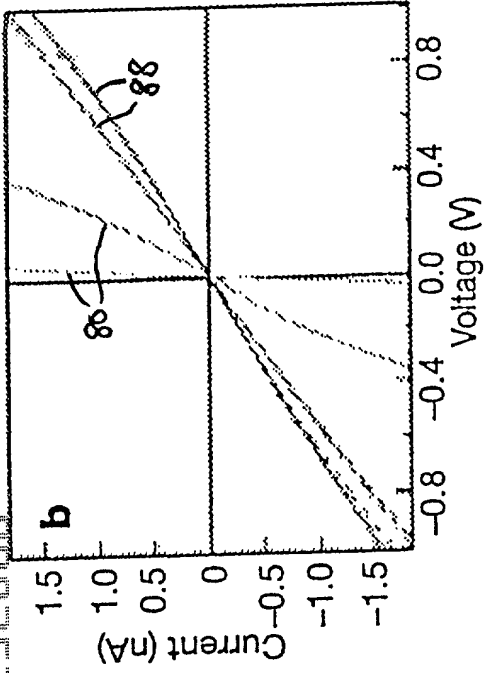


FIG. 23B

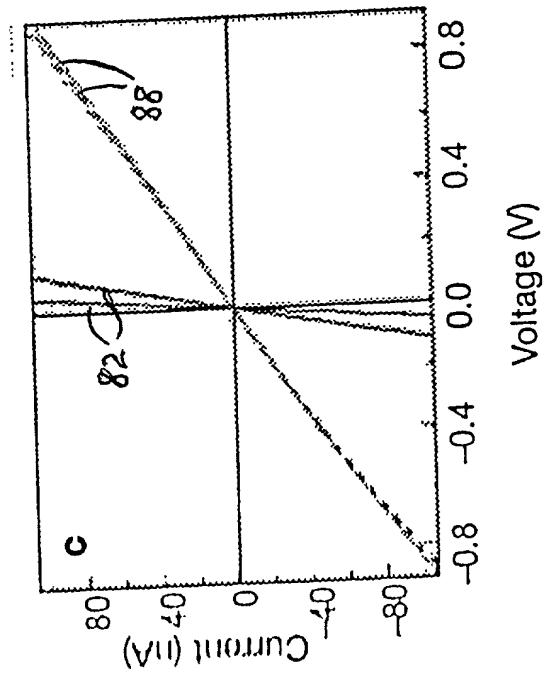


FIG. 23C

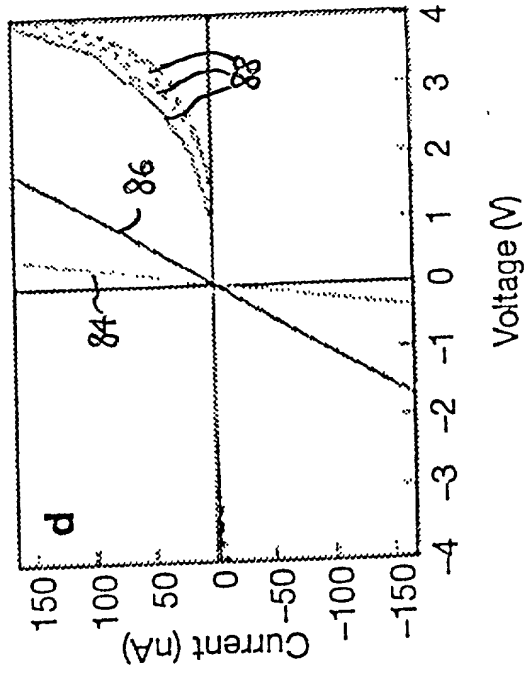


FIG. 23D

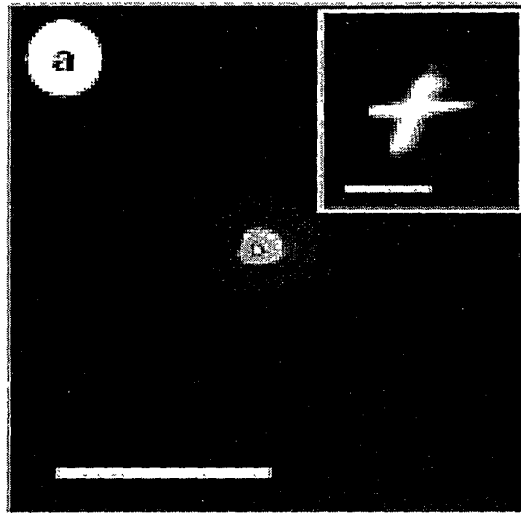


FIG. 24A

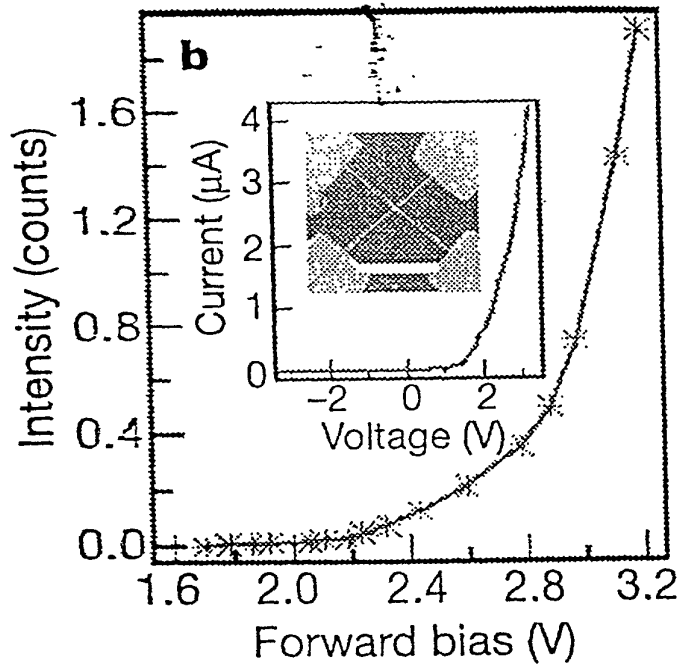
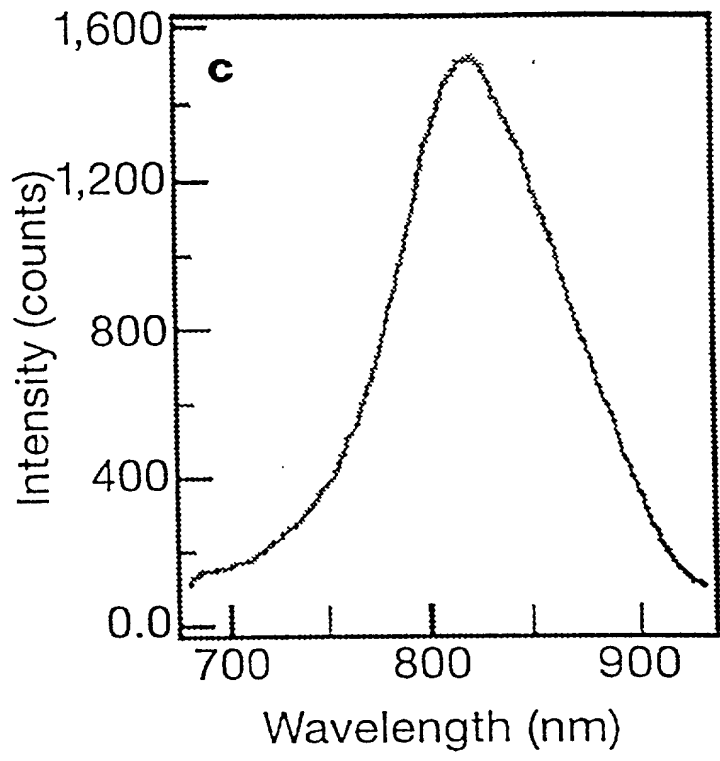


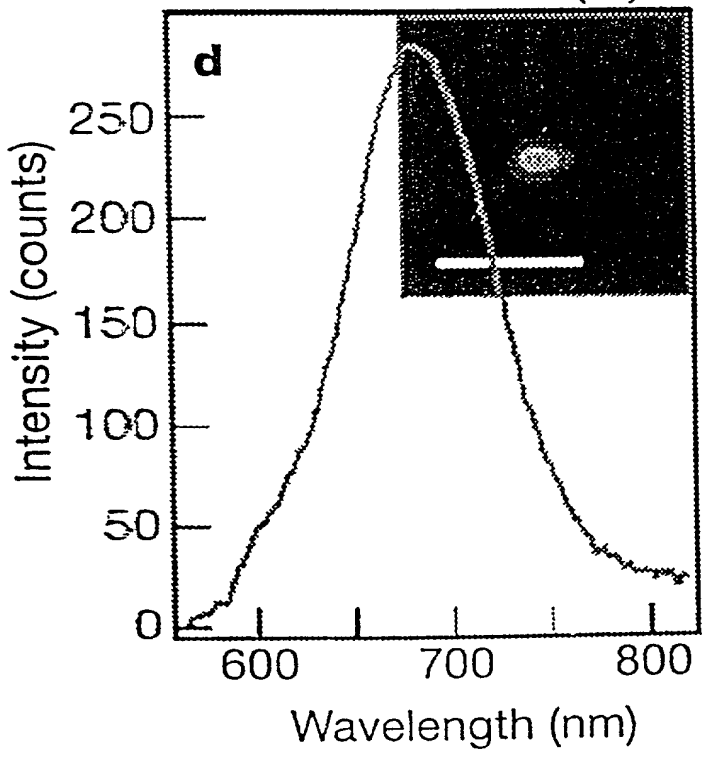
FIG. 24B

PHOTO MICROGRAPH





**FIG. 24C**



**FIG. 24D**

www.nature.com/scientificdata/

www.nature.com/sciencephoto

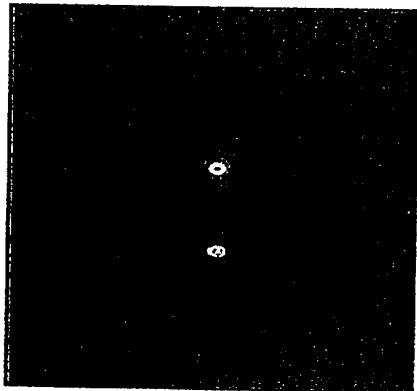


FIG. 25A

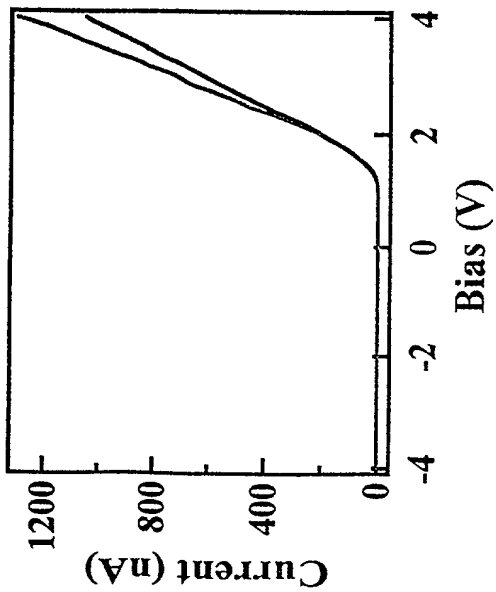


FIG. 25B

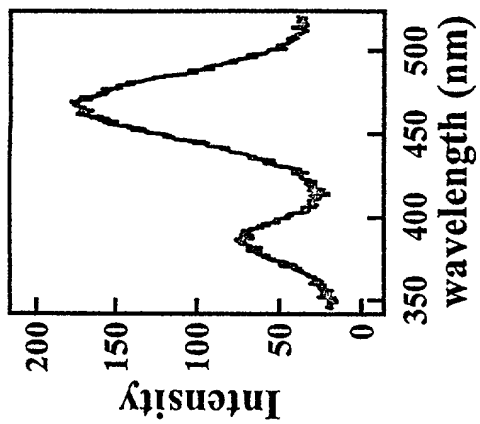
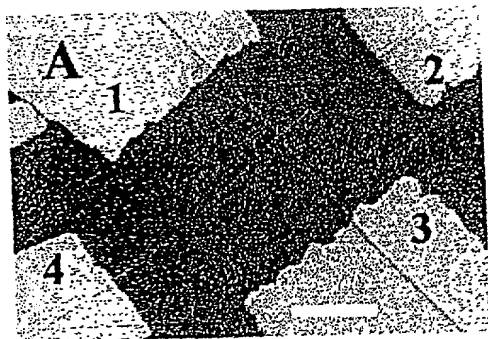
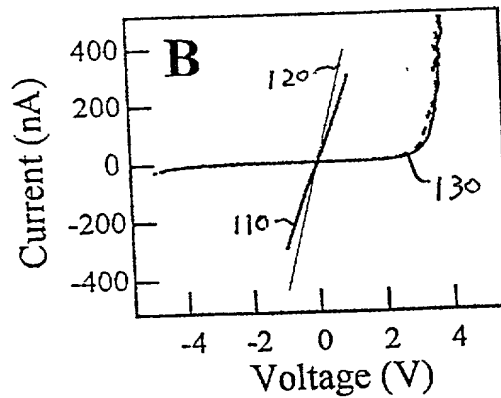


FIG. 25C

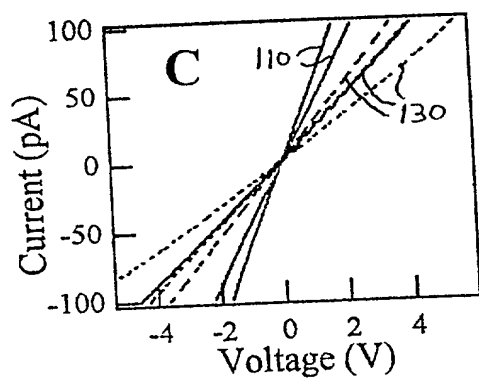




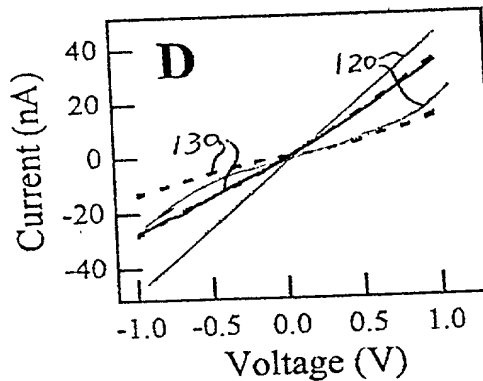
**FIG. 27A**



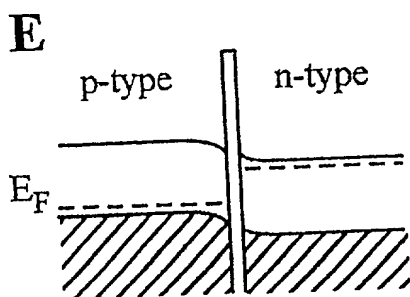
**FIG. 27B**



**FIG. 27C**

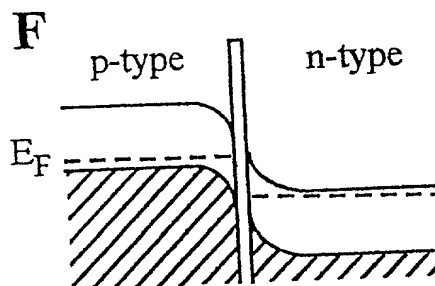


**FIG. 27D**



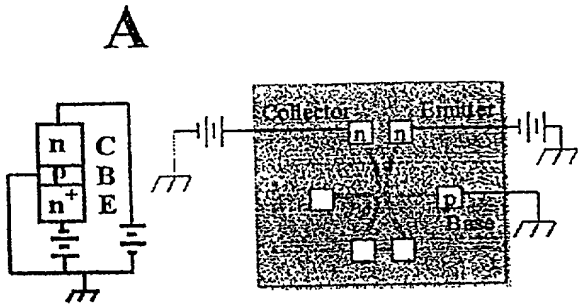
forward bias

**FIG. 27E**

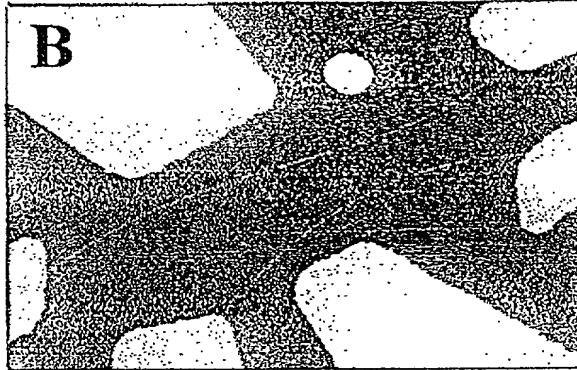


reverse bias

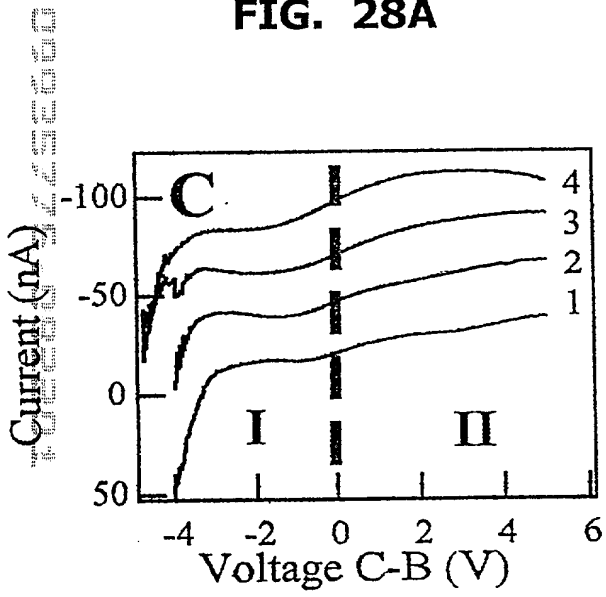
**FIG. 27F**



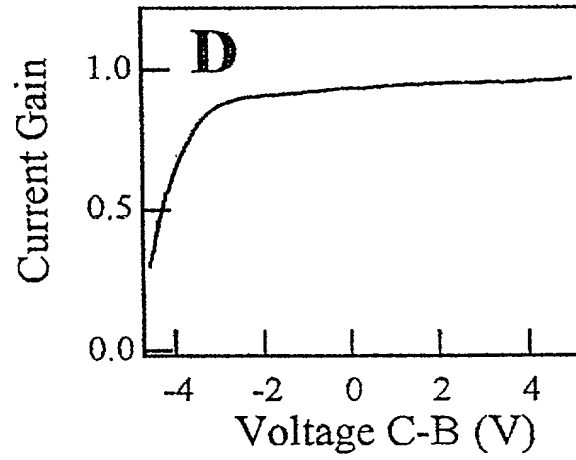
**FIG. 28A**



**FIG. 28B**



**FIG. 28C**



**FIG. 28D**

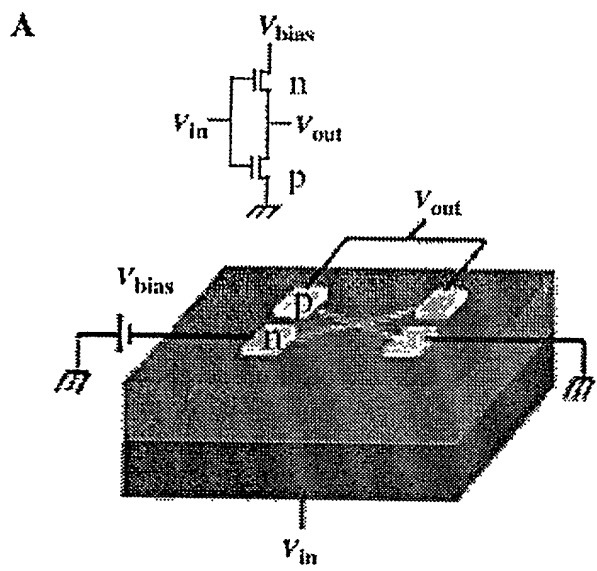


FIG. 29A

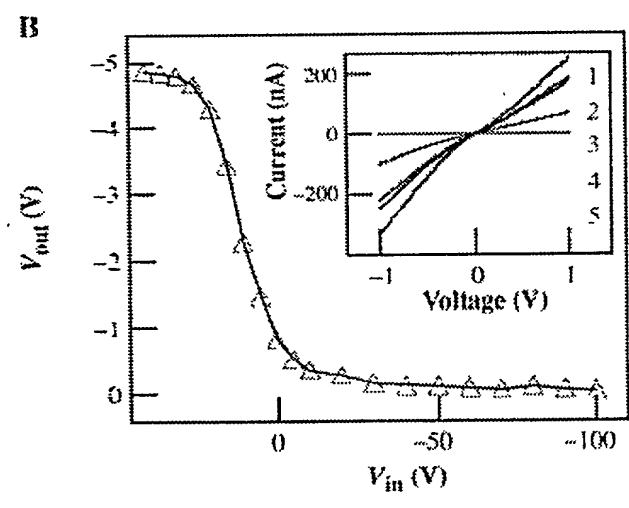


FIG. 29B

www.nature.com/scientificdata/

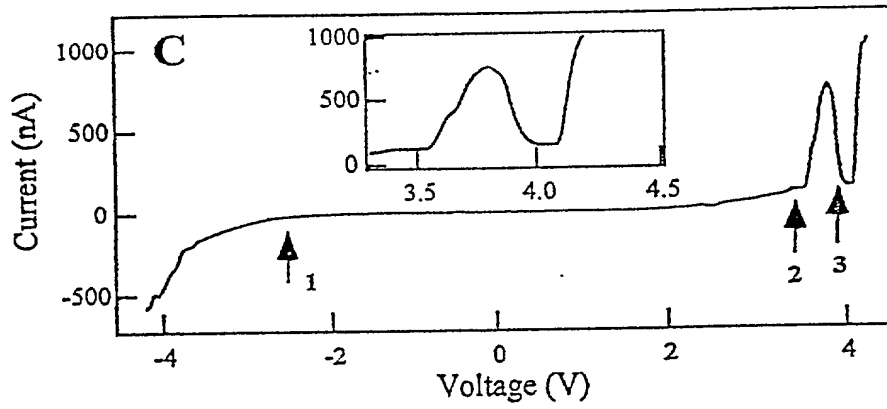


FIG. 29C

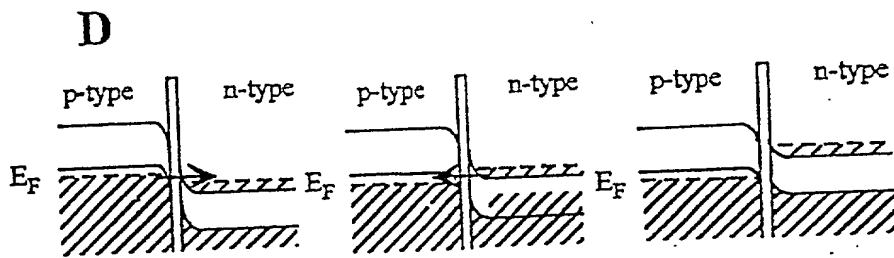


FIG. 29D

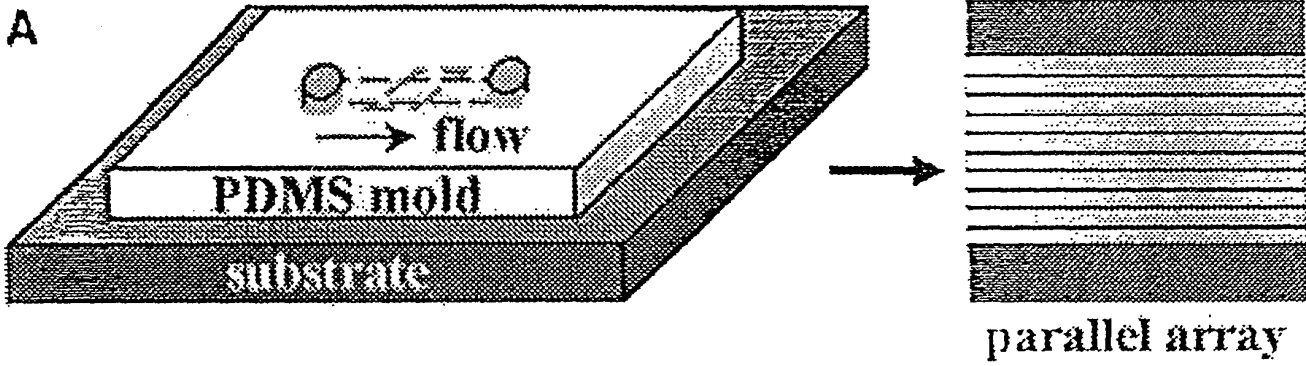


FIG. 30A

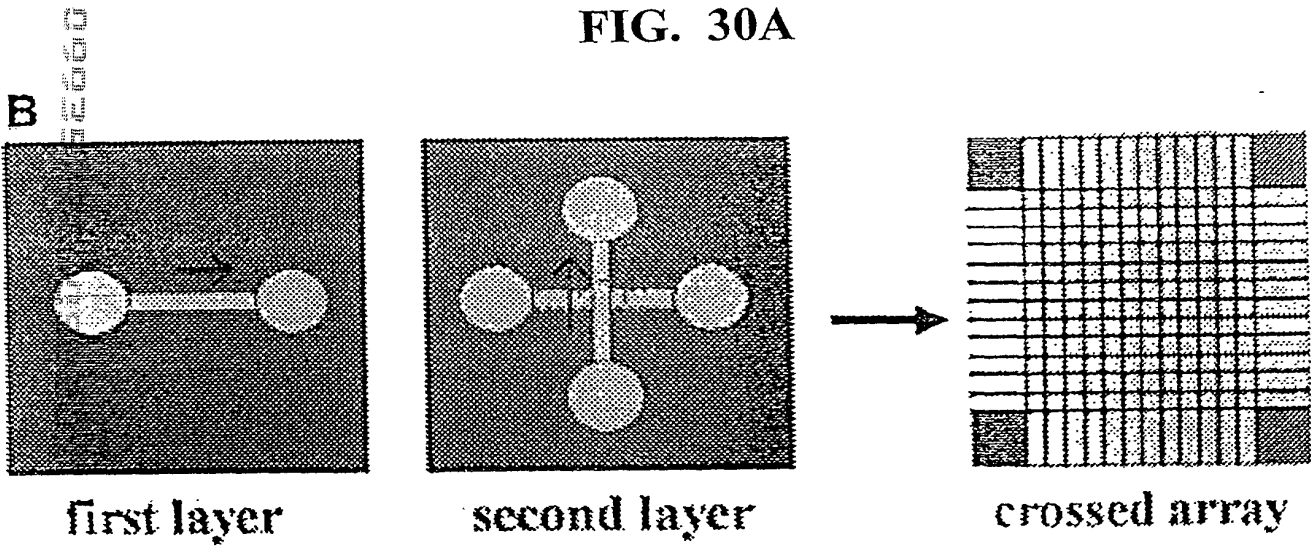


FIG. 30B



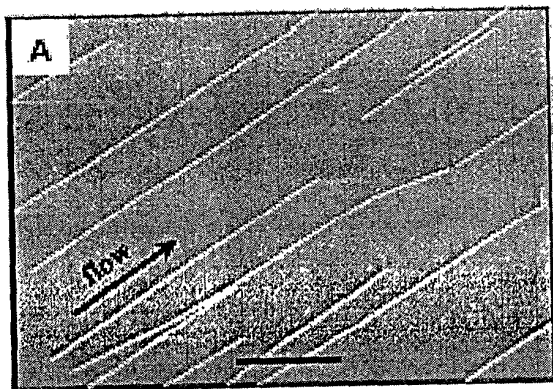


FIG. 31A

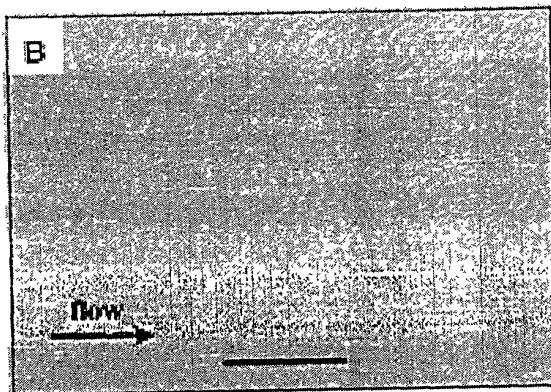


FIG. 31B

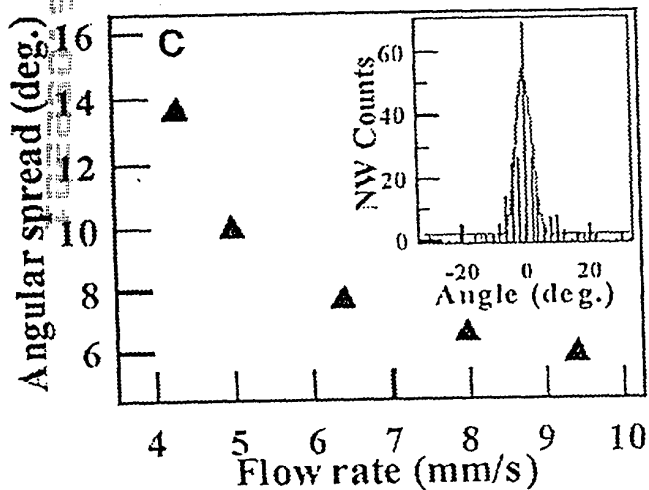


FIG. 31C

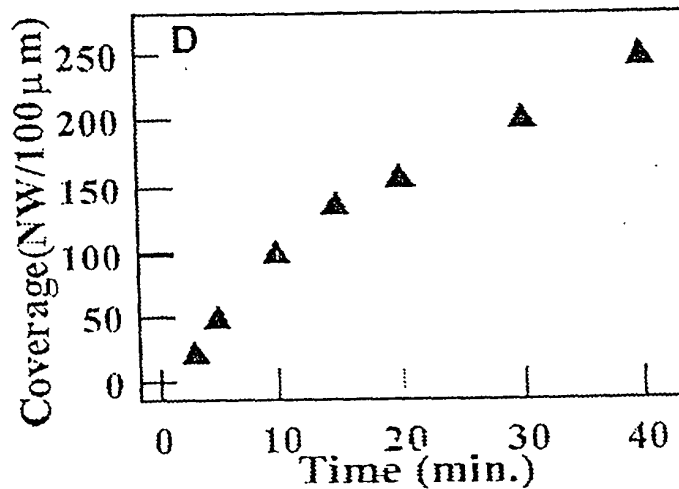


FIG. 31D

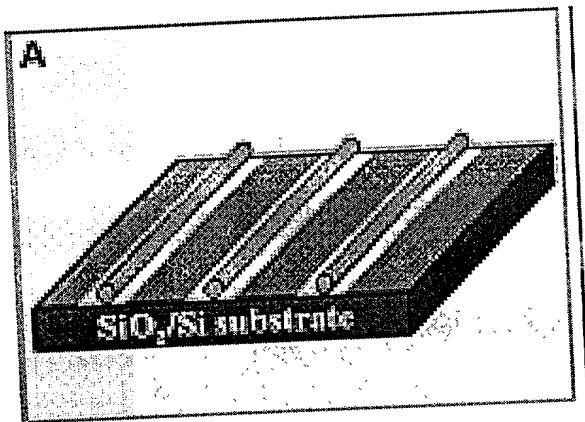


FIG. 32A

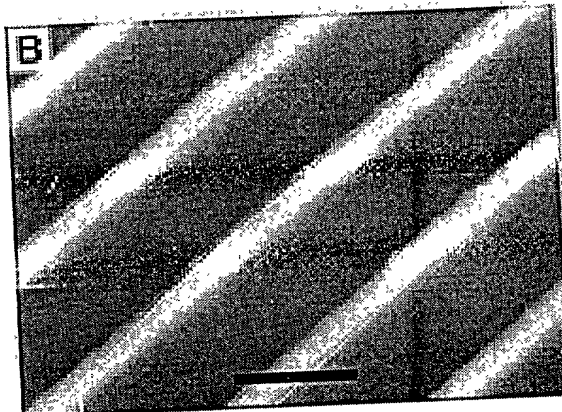


FIG. 32B

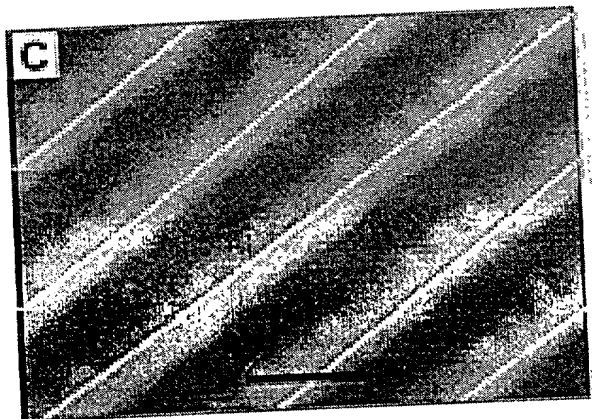


FIG. 32C

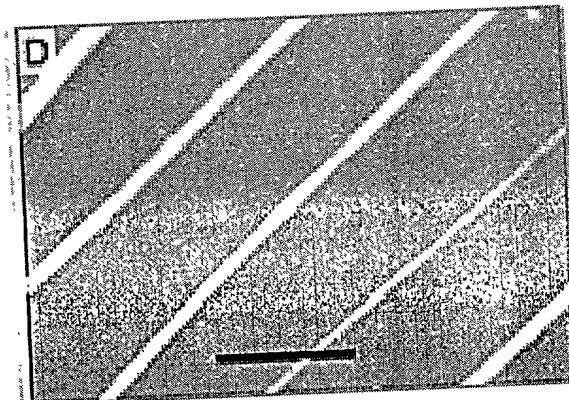


FIG. 32D

Downloaded from ascelibrary.org by Seattle University on 06/01/15

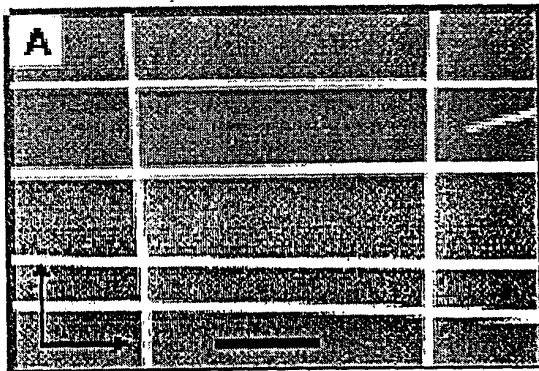


FIG. 33A

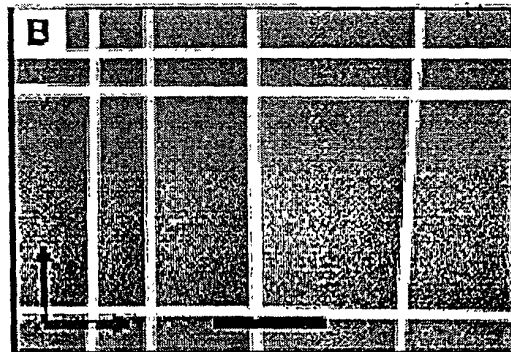


FIG. 33B

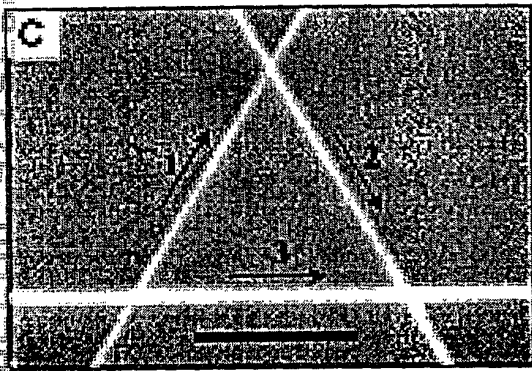


FIG. 33C

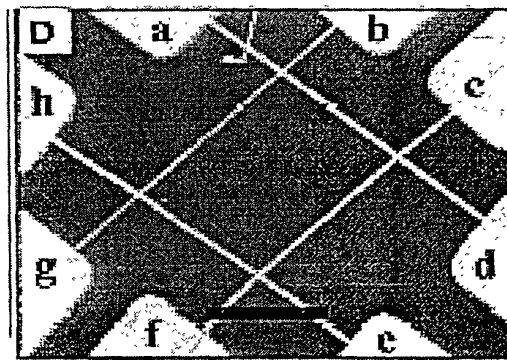


FIG. 33D

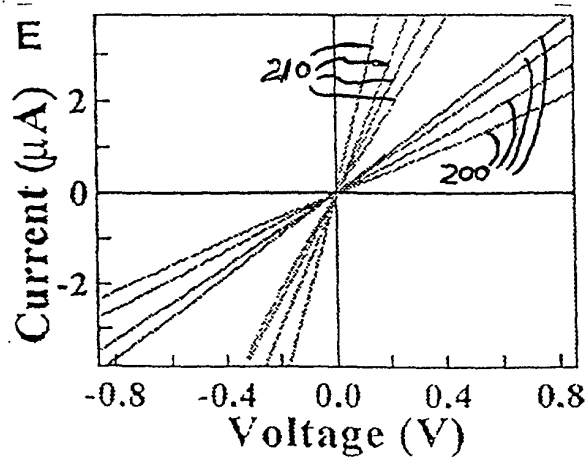


FIG. 33E